



# Workcenters

## **Design Benefits & Features**

- Electrical, fluid and air supplies in convenient locations
- Wide selection on sizes and styles
- High capacity tops and drawers
- Continuous row assemblies
- Wood, steel, stainless steel, laminate and esd (anti-static) tops
- Production boosters, mobile kits, drawers and locks

## **Space Utilization Advantages**

- Efficiently organize work areas
- Tools and storage space are combined into one area
- Ergonomic design increases productivity

## **Market Applications**

- Automotive - service, parts and office
- Education - office and maintenance
- Healthcare - labs, maintenance, and office
- Maintenance - service and parts
- Manufacturing - in-plant offices, work cells, and maintenance
- Military - service, maintenance, and parts
- Office - customer service, shipping/receiving

# Workcenters

Equipto Workcenters provide years of useful, rugged and efficient space utilization. Select from wall mount or free-standing units, with or without drawers, and the largest variety of accessories to take advantage of your work space. Equipto's extensive line of workcenters organize your work areas to make you more productive

- Modular Drawer Cabinet Workcenters maximize storage density
- Closed and Pedestal Leg Workcenters keep tools and parts out of sight
- Open Leg Workcenters provide economical work space
- Tech Bench Workcenters offer a modern answer for keeping reels, hoses, manuals and computer monitors neat and organized
- Equipto Workcenters make flexible use of drawers and cabinets

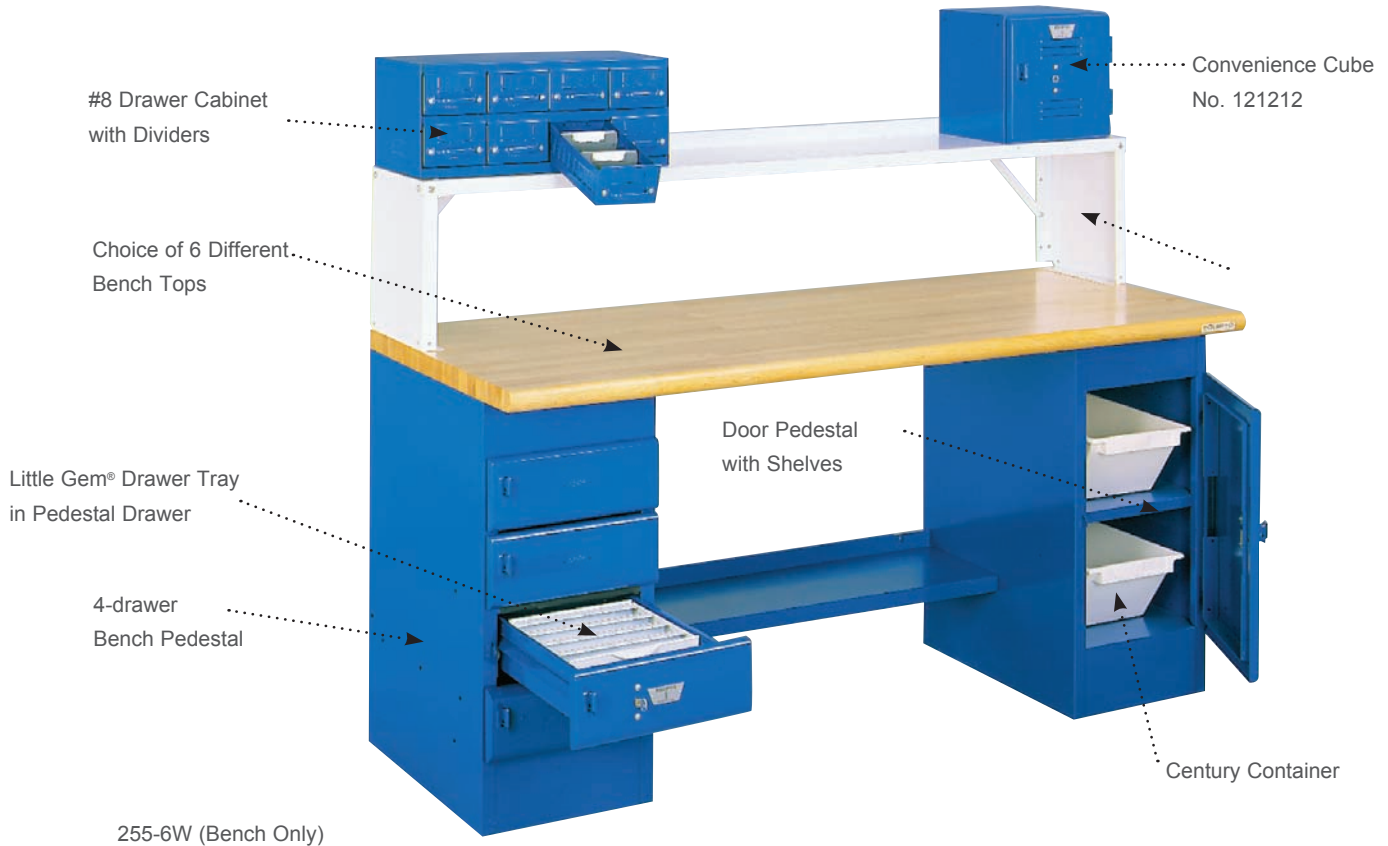

255-6W (Bench Only)

Workcenter accessories allow you to tailor your workcenter to your exact requirements.



Mobile workcenters can be easily moved and configured to create a custom designed work area.



Closed leg workcenters give service bays a uniform, streamlined appearance.

Standard color - office gray. Color coordinating? Refer to the Equipto color chart - inside rear cover. Wood Tops add 13/4" to the overall height of the bench.

# Modular Drawer Cabinet Workcenters

Optimize work areas by combining work and storage space into a modular drawer cabinet workcenter. With capacity up to 400 lbs per drawer, and single or double cabinet configurations, these workcenters are designed to last a lifetime.

## Modular Drawer Cabinet Workcenters - Preconfigured Units

- 22<sup>1</sup>/<sub>2</sub>" wide cabinets feature "Quiet Ride<sup>sm</sup>" Drawers with 200 lb. capacity per drawer
- 30" wide cabinets feature Drawers feature 400 lb. capacity per drawer
- Choice of Equipto vivid colors to enhance work environment
- Knockouts in legs provide for safe, convenient electrical hookup
- Lower recessed shelf
- All benches are 30" deep
- 140 sizes and styles
- Design Efficient workcenters to fit your specific needs
- Choice of 6 tops available in 3 lengths
- Choice of 3 pedestals

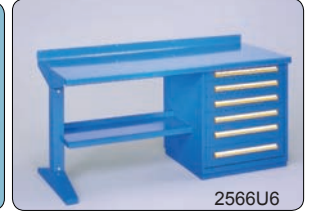

Height	Cabinet Model No.	Length	Steel With Backstop	Wood Top Hardwood	Wood Top Bonded Wood	Hardboard With Backstop	ESD Anti-Static
<b>22<sup>1</sup>/<sub>2</sub>" W Cabinets</b>							
34"	4273	5'	2578U5	2578-5W	2578-5B	2578U5M	2578-5C
		6'	2578U6	2578-6W	2578-6B	2578U6M	2578-6C
		8'	2578U8	2578-8W	2578-8B	2578U8M	2578-8C
29 <sup>1</sup> / <sub>2</sub> "	4263	5'	2563U5	2563-5W	2563-5B	2563U5M	2563-5C
		6'	2563U6	2563-6W	2563-6B	2563U6M	2563-6C
		8'	2563U8	2563-8W	2563-8B	2563U8M	2563-8C
34"	4273	5'	2568U5	2568-5W	2568-5B	2568U5M	2568-5C
		6'	2568U6	2568-6W	2568-6B	2568U6M	2568-6C
		8'	2568U8	2568-8W	2568-8B	2568U8M	2568-8C
<b>30" W Cabinets</b>							
29 <sup>1</sup> / <sub>2</sub> "	4443	5'	2561U5	2561-5W	2561-5B	2561U5M	2561-5C
		6'	2561U6	2561-6W	2561-6B	2561U6M	2561-6C
		8'	2561U8	2561-8W	2561-8B	2561U8M	2561-8C
34"	4433	5'	2566U5	2566-5W	2566-5B	2566U5M	2566-5C
		6'	2566U6	2566-6W	2566-6B	2566U6M	2566-6C
		8'	2566U8	2566-8W	2566-8B	2566U8M	2566-8C

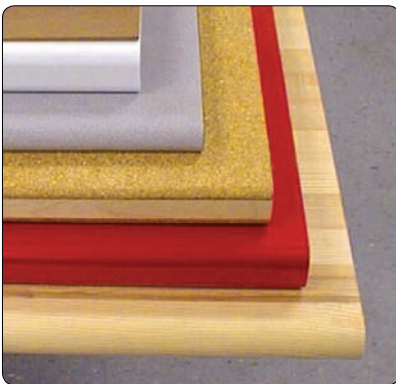

### Tops

#### Choice of 6 tops:

Tempered hardboard bonded to 12 gauge steel; plastic laminate (color: cloud spectrum); ESD (anti-static, color: cloud spectrum - Not shown); 3/8" resin wood bonded to wood block core; 12 gauge (.104") steel; solid laminated hardwood.



Height	Cabinet Model No.	Length	Steel With Backstop	Wood Top Hardwood	Wood Top Bonded Wood	Hardboard With Backstop	ESD Anti-Static
<b>30" W Cabinets</b>							
34"	4433	5'	2586U5	2586-5W	2586-5B	2586U5M	2586-5C
		6'	2586U6	2586-6W	2586-6B	2586U6M	2586-6C
		8'	2586U8	2586-8W	2586-8B	2586U8M	2586-8C
34"	4433	5'	2576U5	2576-5W	2576-5B	2576U5M	2576-5C
		6'	2576U6	2576-6W	2576-6B	2576U6M	2576-6C
		8'	2576U8	2576-8W	2576-8B	2576U8M	2576-8C
29 <sup>1</sup> / <sub>2</sub> "	4443	8'	2591U8	2591-8W	2591-8B	2591U8M	2591-8C
34"	4433	8'	2596U8	2596-8W	2596-8B	2596U8M	2596-8C

On 8' benches, the legs are on 6' centers. The top overhangs legs 1' on each side. Pages 97-98 feature Productivity Enhancements for these benches.

Standard color - office gray. Color coordinating? Refer to the Equipto color chart - inside rear cover. Wood Tops add 1<sup>3</sup>/<sub>4</sub>" to the overall height of the bench.

Workcenters

# Closed Leg Workcenters

Equipto closed leg benches combine high-efficiency bench features with the important benefits of cabinet space. Choose from more than 200 sizes and styles and a range of features to match your exact needs. Rugged structural unit designed for tough use with the flexibility for adding accessories.

## Closed Leg Workcenters - Preconfigured Units

Benches are all 30" deep and 34" high.



275U6

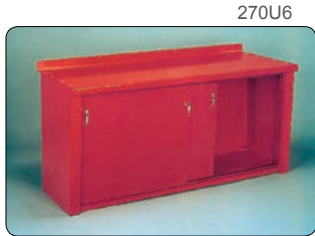

270U6



280U6



210U6



215U6



265U6



Series	Length	Steel Tops Backstop		Wood Tops		Hardboard on Steel Backstop		ESD Anti-Static
		With	Without	Hardwood	Bonded Wood	With	Without	
<b>270 Series - Includes Doors Only</b>								
	4'	270U4	270D4	270-4W	270-4B	270U4M	270D4M	270-4C
	5'	270U5	270D5	270-5W	270-5B	270U5M	270D5M	270-5C
	6'	270U6	270D6	270-6W	270-6B	270U6M	270D6M	270-6C
	8'	270U8	270D8	270-8W	270-8B	270U8M	270D8M	270-8C

<b>275 Series - Includes Doors &amp; 1 Shelf</b>								
	4'	275U4	275D4	275-4W	275-4B	275U4M	275D4M	275-4C
	5'	275U5	275D5	275-5W	275-5B	275U5M	275D5M	275-5C
	6'	275U6	275D6	275-6W	275-6B	275U6M	275D6M	275-6C
	8'	275U8	275D8	275-8W	275-8B	275U8M	275D8M	275-8C

<b>280 Series - Includes 1 Shelf &amp; 1 Drawer</b>								
	4'	280U4	280D4	280-4W	280-4B	280U4M	280D4M	280-4C
	5'	280U5	280D5	280-5W	280-5B	280U5M	280D5M	280-5C
	6'	280U6	280D6	280-6W	280-6B	280U6M	280D6M	280-6C
	8'	280U8	280D8	280-8W	280-8B	280U8M	280D8M	280-8C

Series	Length	Steel Tops Backstop		Wood Tops		Hardboard on Steel Backstop		ESD Anti-Static
		With	Without	Hardwood	Bonded Wood	With	Without	
<b>210 Series - Open Backed Bench , Includes 1 Half Shelf And 1 Drawer</b>								
	4'	210U4	210D4	210-4W	210-4B	210U4M	210D4M	210-4C
	5'	210U5	210D5	210-5W	210-5B	210U5M	210D5M	210-5C
	6'	210U6	210D6	210-6W	210-6B	210U6M	210D6M	210-6C
	8'	210U8	210D8	210-8W	210-8B	210U8M	210D8M	210-8C

<b>215 Series - Open Backed Bench , Includes 1 Half Shelf</b>								
	4'	215U4	215D4	215-4W	215-4B	215U4M	215D4M	215-4C
	5'	215U5	215D5	215-5W	215-5B	215U5M	215D5M	215-5C
	6'	215U6	215D6	215-6W	215-6B	215U6M	215D6M	215-6C
	8'	215U8	215D8	215-8W	215-8B	215U8M	215D8M	215-8C

<b>265 Series - Closed Backed Bench , Includes 1 Full Shelf</b>								
	4'	265U4	265D4	265-4W	265-4B	265U4M	265D4M	265-4C
	5'	265U5	265D5	265-5W	265-5B	265U5M	265D5M	265-5C
	6'	265U6	265D6	265-6W	265-6B	265U6M	265D6M	265-6C
	8'	265U8	265D8	265-8W	265-8B	265U8M	265D8M	265-8C

On 8' benches, the legs are on 6' centers. The top overhangs legs 1' on each side.

Pages 97-98 feature Productivity Enhancements for these benches.

### Closed Leg Cabinet

Bench with doors Part No. 295

34"H x 36"W x 26<sup>3/8</sup>"D

- Double doors, chrome locking handle, and two shelves provide convenient space for supplies
- Ideal for small office copiers, postage meters, fax machines, etc.

Standard color - office gray. Color coordinating? Refer to the Equipto color chart - inside rear cover. Wood Tops add 1<sup>3/4</sup>" to the overall height of the bench.

# Pedestal Workcenters

Equipto Pedestal Benches offer the perfect bench/cabinet combination and feature strong, rugged work surfaces, lower shelf space and lockable cabinets and drawers. Customize with accessories and over 180 combinations of height, length, depth, and top surfaces.

- Bench can be customized to fit your specific needs
- Choice of 6 tops available in 4 lengths
- Lower recessed shelf
- Door cabinets have middle shelf
- All benches are 30" deep
- All Cabinets are 34"H x 15"W

## Pedestal Workcenters - Preconfigured Units

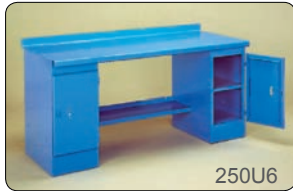

250U6



255U6



260U6



240U6



245U6

Series	Length	Steel Tops Backstop		Wood Tops Bonded		Hardboard on Steel Backstop		ESD Anti-Static
		With	Without	Hardwood	Wood	With	Without	
<b>250 Series - Includes 2 Door Pedestals</b>								
	4'	250U4	250D4	250-4W	250-4B	250U4M	250D4M	250-4C
	5'	250U5	250D5	250-5W	250-5B	250U5M	250D5M	250-5C
	6'	250U6	250D6	250-6W	250-6B	250U6M	250D6M	250-6C
	8'	250U8	250D8	250-8W	250-8B	250U8M	250D8M	250-8C

<b>255 Series - Includes 1 Drawer Pedestal And 1 Door Pedestal</b>								
	4'	255U4	255D4	255-4W	255-4B	255U4M	255D4M	255-4C
	5'	255U5	255D5	255-5W	255-5B	255U5M	255D5M	255-5C
	6'	255U6	255D6	255-6W	255-6B	255U6M	255D6M	255-6C
	8'	255U8	255D8	255-8W	255-8B	255U8M	255D8M	255-8C

<b>260 Series - Includes 2 Drawer Pedestals</b>								
	4'	260U4	260D4	260-4W	260-4B	260U4M	260D4M	260-4C
	5'	260U5	260D5	260-5W	260-5B	260U5M	260D5M	260-5C
	6'	260U6	260D6	260-6W	260-6B	260U6M	260D6M	260-6C
	8'	260U8	260D8	260-8W	260-8B	260U8M	260D8M	260-8C

On 8' benches, the legs are on 6' centers. The top overhangs legs 1' on each side.

Pages 106-108 Feature Productivity Enhancements for These Benches.

Series	Length	Steel Tops Backstop		Wood Tops Bonded		Hardboard on Steel Backstop		ESD Anti-Static
		With	Without	Hardwood	Wood	With	Without	
<b>240 Series - Includes 1 Closed Leg And 1 Door Pedestal</b>								
	4'	240U4	240D4	240-4W	240-4B	240U4M	240D4M	240-4C
	5'	240U5	240D5	240-5W	240-5B	240U5M	240D5M	240-5C
	6'	240U6	240D6	240-6W	240-6B	240U6M	240D6M	240-6C
	8'	240U8	240D8	240-8W	240-8B	240U8M	240D8M	240-8C

<b>245 Series - Includes 1 Closed Leg And 1 Drawer Pedestal</b>								
	4'	245U4	245D4	245-4W	245-4B	245U4M	245D4M	245-4C
	5'	245U5	245D5	245-5W	245-5B	245U5M	245D5M	245-5C
	6'	245U6	245D6	245-6W	245-6B	245U6M	245D6M	245-6C
	8'	245U8	245D8	245-8W	245-8B	245U8M	245D8M	245-8C

On 8' benches, the legs are on 6' centers. The top overhangs legs 1' on each side.

Pages 97-98 Feature Productivity Enhancements for these benches.

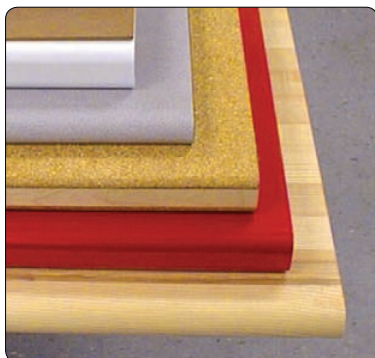

### Tops

#### Choice of 6 tops:

- tempered hardboard bonded to 12 gauge steel;
- plastic laminate (color: cloud spectrum); ESD (anti-static, color: cloud spectrum - Not shown);
- 3/8" resin wood bonded to wood block core;
- 12 gauge (.104") steel; solid laminated hardwood.

For drawer specifications See pgs.

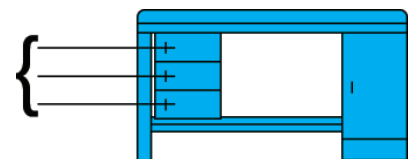

As many as 9 drawers (6 in the 4' unit) can be added to the 210 and 215 series benches.

Standard color - office gray. Color coordinating? Refer to the Equipto color chart - inside rear cover. Wood Tops add 1<sup>3/4</sup>" to the overall height of the bench.

# Adjustable Height Iron-I Workcenters

Equipto's Iron-I Workcenters are completely adjustable and are available in 2 depths and 4 lengths with over 35 varying leg heights! You can choose from 5 standard tops to customize to your specific requirements

- Adjustable height 26" to 44"
- Three-way adjustable shelf
- Electrical, air and fluid power knockouts on each leg
- Heavy-Duty cantilever leg design eliminates obstruction of corner leg design

**IRON-I**<sup>®</sup>

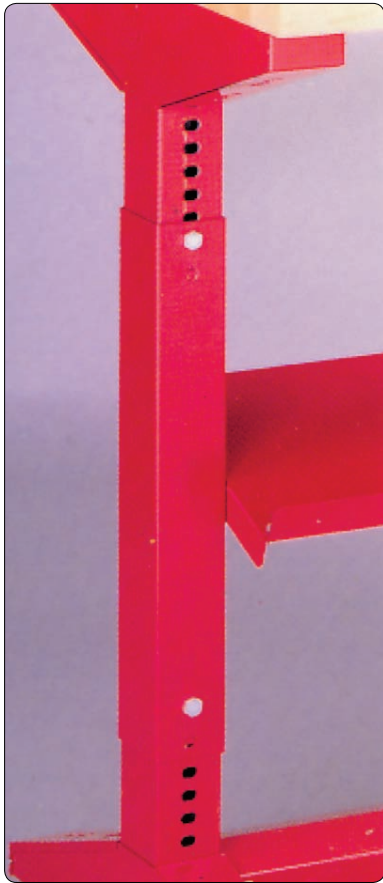

**Adjustability**

Total adjustability. Leg heights from 26" to 44" in 1/2" increments.



**Adjust position**

Shelf can be adjusted to be closer to front or back of bench.



**Adjustable slope**

Shelf can be sloped toward front or toward rear of bench.



**Adjustable height**

Shelf can be located in any one of 3 height positions.



**Electric power**

Each bench has knockouts for 8 electrical outlets. Knockouts are in both top and bottom of each leg.



**Air or fluid power**

Each bench has 4 knockouts for Air or Fluid power. Knockouts are in both top and bottom of leg.

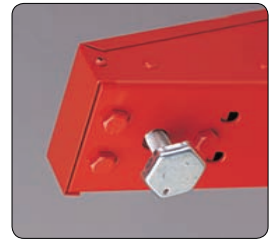

**Optional levelers**

Each bench leg can be equipped with an optional leveler to achieve exact height and level needed. Part No. 11650-04

Patents Pending

Page 99 features Productivity Enhancements for these benches.

Standard color - office gray. Color coordinating? Refer to the Equipto color chart - inside rear cover. Wood Tops add 13/4" to the overall height of the bench.

Workcenters

**Adjustable Height Iron-I Workcenters - Preconfigured Units**

- Lower shelf adjusts to three heights and tilts front or back to fit your application
- More than 445 sizes
- Back and side rails keep parts on top of workcenter
- Adjustable from 26" to 36" or from 34" to 44" in 1/2" increments to meet your exact height requirements
- Aerial shelf adds space for increased productivity
- Depending on type of top, workbench will support up to 1,800 lbs.

**Iron-I Bench without shelf**

Depth	Height	Length	Steel Tops		Wood Tops		Hardboard on Steel		ESD Anti-Static	
			Backstop		Hardwood	Bonded Wood	Backstop			
			With	Without					With	Without
<b>30" Depth</b>										
	26"	4'	421U4	421D4	421-4W	421-4B	421U4M	421D4M	421-4C	
	to	5'	421U5	421D5	421-5W	421-5B	421U5M	421D5M	421-5C	
	36"	6'	421U6	421D6	421-6W	421-6B	421U6M	421D6M	421-6C	
		8'	421U8	421D8	421-8W	421-8B	421U8M	421D8M	421-8C	
	34"	4'	422U4	422D4	422-4W	422-4B	422U4M	422D4M	422-4C	
	to	5'	422U5	422D5	422-5W	422-5B	422U5M	422D5M	422-5C	
	44"	6'	422U6	422D6	422-6W	422-6B	422U6M	422D6M	422-6C	
		8'	422U8	422D8	422-8W	422-8B	422U8M	422D8M	422-8C	
<b>36" Depth</b>										
	26"	4'	431U4	431D4	431-4W	431-4B	431U4M	431D4M	431-4C	
	to	5'	431U5	431D5	431-5W	431-5B	431U5M	431D5M	431-5C	
	36"	6'	431U6	431D6	431-6W	431-6B	431U6M	431D6M	431-6C	
		8'	431U8	431D8	431-8W	431-8B	431U8M	431D8M	431-8C	
	34"	4'	432U4	432D4	432-4W	432-4B	432U4M	432D4M	432-4C	
	to	5'	432U5	432D5	432-5W	432-5B	432U5M	432D5M	432-5C	
	44"	6'	432U6	432D6	432-6W	432-6B	432U6M	432D6M	432-6C	
		8'	432U8	432D8	432-8W	432-8B	432U8M	432D8M	432-8C	



Iron-I Bench **without** lower shelf

8' bench legs are on 6' centers. The top overhangs legs 1' on each side.

Page 99 features Productivity Enhancements for these benches.

**Iron-I Bench with lower shelf**

Depth	Height	Length	Steel Tops		Wood Tops		Hardboard on Steel		ESD Anti-Static	
			Backstop		Hardwood	Bonded Wood	Backstop			
			With	Without					With	Without
<b>30" Depth</b>										
	26"	4'	423U4	423D4	423-4W	423-4B	423U4M	423D4M	423-4C	
	to	5'	423U5	423D5	423-5W	423-5B	423U5M	423D5M	423-5C	
	36"	6'	423U6	423D6	423-6W	423-6B	423U6M	423D6M	423-6C	
		8'	423U8	423D8	423-8W	423-8B	423U8M	423D8M	423-8C	
	34"	4'	424U4	424D4	424-4W	424-4B	424U4M	424D4M	424-4C	
	to	5'	424U5	424D5	424-5W	424-5B	424U5M	424D5M	424-5C	
	44"	6'	424U6	424D6	424-6W	424-6B	424U6M	424D6M	424-6C	
		8'	424U8	424D8	424-8W	424-8B	424U8M	424D8M	424-8C	
<b>36" Depth</b>										
	26"	4'	433U4	433D4	433-4W	433-4B	433U4M	433D4M	433-4C	
	to	5'	433U5	433D5	433-5W	433-5B	433U5M	433D5M	433-5C	
	36"	6'	433U6	433D6	433-6W	433-6B	433U6M	433D6M	433-6C	
		8'	433U8	433D8	433-8W	433-8B	433U8M	433D8M	433-8C	
	34"	4'	434U4	434D4	434-4W	434-4B	434U4M	434D4M	434-4C	
	to	5'	434U5	434D5	434-5W	434-5B	434U5M	434D5M	434-5C	
	44"	6'	434U6	434D6	434-6W	434-6B	434U6M	434D6M	434-6C	
		8'	434U8	434D8	434-8W	434-8B	434U8M	434D8M	434-8C	



Iron-I Bench **with** lower shelf

8' bench legs are on 6' centers. The top overhangs legs 1' on each side.

Page 99 features Productivity Enhancements for these benches.

Standard color - office gray. Color coordinating? Refer to the Equipto color chart - inside rear cover. Wood Tops add 1<sup>3/4"</sup> to the overall height of the bench.

**Adjustable Height Iron-I Workcenters - Preconfigured Units cont'd**

**Iron-I Bench with lower shelf and rails**

Height	Length	Wood Tops				ESD Anti-Static
		Steel with Backstop	Hardwood	Bonded Wood	Hardboard with Backstop	
<b>30" Depth</b>						
26"	4'	425U4	425-4W	425-4B	425U4M	425-4C
to	5'	425U5	425-5W	425-5B	425U5M	425-5C
36"	6'	425U6	425-6W	425-6B	425U6M	425-6C
	8'	425U8	425-8W	425-8B	425U8M	425-8C
34"	4'	426U4	426-4W	426-4B	426U4M	426-4C
to	5'	426U5	426-5W	426-5B	426U5M	426-5C
44"	6'	426U6	426-6W	426-6B	426U6M	426-6C
	8'	426U8	426-8W	426-8B	426U8M	426-8C
<b>36" Depth</b>						
26"	4'	435U4	435-4W	435-4B	435U4M	435-4C
to	5'	435U5	435-5W	435-5B	435U5M	435-5C
36"	6'	435U6	435-6W	435-6B	435U6M	435-6C
	8'	435U8	435-8W	435-8B	435U8M	435-8C
34"	4'	436U4	436-4W	436-4B	436U4M	436-4C
to	5'	436U5	436-5W	436-5B	436U5M	436-5C
44"	6'	436U6	436-6W	436-6B	436U6M	436-6C
	8'	436U8	436-8W	436-8B	436U8M	436-8C



Iron-I Bench **with** lower shelf, and side and back rails

8' bench legs are on 6' centers. The top overhangs legs 1' on each side.  
Page 99 features Productivity Enhancements for these benches.

**Iron-I Bench with lower shelf, aerial shelf, drawer, and rails**

Depth	Height	Length	Wood Tops				ESD Anti-Static
			Steel with Backstop	Hardwood	Bonded Wood	Hardboard with Backstop	
<b>30" Depth</b>							
		4'	427U4	427-4W	427-4B	427U4M	427-4C
26"	5'		427U5	427-5W	427-5B	427U5M	427-5C
to	6'		427U6	427-6W	427-6B	427U6M	427-6C
36"	8'		427U8	427-8W	427-8B	427U8M	427-8C
34"	4'		428U4	428-4W	428-4B	428U4M	428-4C
to	5'		428U5	428-5W	428-5B	428U5M	428-5C
44"	6'		428U6	428-6W	428-6B	428U6M	428-6C
	8'		428U8	428-8W	428-8B	428U8M	428-8C
<b>36" Depth</b>							
		4'	437U4	437-4W	437-4B	437U4M	437-4C
26"	5'		437U5	437-5W	437-5B	437U5M	437-5C
to	6'		437U6	437-6W	437-6B	437U6M	437-6C
36"	8'		437U8	437-8W	437-8B	437U8M	437-8C
34"	4'		438U4	438-4W	438-4B	438U4M	438-4C
to	5'		438U5	438-5W	438-5B	438U5M	438-5C
44"	6'		438U6	438-6W	438-6B	438U6M	438-6C
	8'		438U8	438-8W	438-8B	438U8M	438-8C



Iron-I Bench **with** lower shelf, aerial shelf, drawer and rails

8' bench legs are on 6' centers. The top overhangs legs 1' on each side.  
Page 99 features Productivity Enhancements for these benches.

Standard color - office gray. Color coordinating? Refer to the Equipto color chart - inside rear cover. Wood Tops add 1<sup>3/4"</sup> to the overall height of the bench.



# Teardown Bench

## Teardown bench features and benefits

- Ideal for working on transmissions, small engines and hydraulic components
- Reinforced work surface will stand up to years of heavy use
- Top has a 3/4" high retaining lip on all sides tapering to the rear center to a 1/2" threaded and plumbed drain
- Optional caster kit consists of 4 swivel 7<sup>1/2</sup>"H casters
- 1/2" threaded drain nipple allows for connection of a hose to divert fluid to a storage container; or capture fluid with an optional fluid container kit



2303DT shown with optional fluid container, drawer kit and shelf.

## Teardown Benches

Part No.	Description	Depth	Length	Leg Height
2301DT	Steel Top	30"	48"	29"
2303DT	Steel Top	30"	48"	34"
2311DT	Steel Top	30"	60"	29"
2313DT	Steel Top	30"	60"	34"
2301DTSS	Stainless Steel Top	30"	48"	29"
2303DTSS	Stainless Steel Top	30"	48"	34"
2311DTSS	Stainless Steel Top	30"	60"	29"
2313DTSS	Stainless Steel Top	30"	60"	34"

## Kits and Accessories

Part No.	Description	Depth	Length	Leg Height
2304DT	Kit Support Channels	-	48"	-
2305DT	Kit Support Channels	-	60"	-
2307DT	Fluid Container Kit-White*	22"	11"	7"
221DT	Drawer Kit*	23"	15"	6 <sup>1/4</sup> "
2203	Caster Kit	30"	-	-
6120	Bottom Shelf	12 <sup>7/8</sup> "	48"	-
6121	Bottom Shelf	12 <sup>7/8</sup> "	60"	-

\*Kit support channels are required when ordering a fluid container kit or a drawer kit. If both kits are ordered for the same bench, only one set of kit support channels is needed.



2307DT Fluid Container Kit



221DT - Drawer Kit



2203 - Caster Kit

## Wall mount Open Leg Bench

		Wood Tops				
		Steel Tops	Bonded		Hardboard	ESD
Depth	Length	With Backstop	Hardwood	Wood	With Backstop	Anti-Static
<b>30" Depth</b>						
	30"	2340U3	2340-3W	2340-3B	2340U3M	—
	4'	2340U4	2340-4W	2340-4B	2340U4M	2340-4C
	5'	2340U5	2340-5W	2340-5B	2340U5M	2340-5C
	6'	2340U6	2340-6W	2340-6B	2340U6M	2340-6C
	8'	2340U8	2340-8W	2340-8B	2340U8M	2340-8C
<b>36" Depth</b>						
	30"	2345U3	2345-3W	2345-3B	2345U3M	—
	4'	2345U4	2345-4W	2345-4B	2345U4M	2345-4C
	5'	2345U5	2345-5W	2345-5B	2345U5M	2345-5C
	6'	2345U6	2345-6W	2345-6B	2345U6M	2345-6C
	8'	2345U8	2345-8W	2345-8B	2345U8M	2345-8C

- Easy to anchor to wall
- Clean-up of work area is easy
- Efficient use of wall space



2345U6

Standard color - office gray. Color coordinating? Refer to the Equipto color chart - inside rear cover. Wood Tops add 1<sup>3/4</sup>" to the overall height of the bench.

# Open Leg Workcenters

A simple and convenient way to achieve efficient work space with economy and endurance.

This basic unit is designed to boost your productivity over years and years of demanding use.

## Open Leg Workcenters - 2200 series

Depth	Height	Length	Steel Top Backstop		Wood Tops		Hardboard Backstop		ESD Anti-Static
			With	Without	Hardwood	Bonded Wood	With	Without	
<b>30" Depth</b>									
29"	4'	2221U4	2221D4	2221-4W	2221-4B	2221U4M	2221D4M	2221-4C	
		2221U5	2221D5	2221-5W	2221-5B	2221U5M	2221D5M	2221-5C	
		2221U6	2221D6	2221-6W	2221-6B	2221U6M	2221D6M	2221-6C	
		2221U8	2221D8	2221-8W	2221-8B	2221U8M	2221D8M	2221-8C	
31 1/4"	4'	2222U4	2222D4	2222-4W	2222-4B	2222U4M	2222D4M	2222-4C	
		2222U5	2222D5	2222-5W	2222-5B	2222U5M	2222D5M	2222-5C	
		2222U6	2222D6	2222-6W	2222-6B	2222U6M	2222D6M	2222-6C	
		2222U8	2222D8	2222-8W	2222-8B	2222U8M	2222D8M	2222-8C	
34"	4'	2223U4	2223D4	2223-4W	2223-4B	2223U4M	2223D4M	2223-4C	
		2223U5	2223D5	2223-5W	2223-5B	2223U5M	2223D5M	2223-5C	
		2223U6	2223D6	2223-6W	2223-6B	2223U6M	2223D6M	2223-6C	
		2223U8	2223D8	2223-8W	2223-8B	2223U8M	2223D8M	2223-8C	



<b>36" Depth</b>									
29"	4'	2231U4	2231D4	2231-4W	2231-4B	2231U4M	2231D4M	2231-4C	
		2231U5	2231D5	2231-5W	2231-5B	2231U5M	2231D5M	2231-5C	
		2231U6	2231D6	2231-6W	2231-6B	2231U6M	2231D6M	2231-6C	
		2231U8	2231D8	2231-8W	2231-8B	2231U8M	2231D8M	2231-8C	
31 1/4"	4'	2232U4	2232D4	2232-4W	2232-4B	2232U4M	2232D4M	2232-4C	
		2232U5	2232D5	2232-5W	2232-5B	2232U5M	2232D5M	2232-5C	
		2232U6	2232D6	2232-6W	2232-6B	2232U6M	2232D6M	2232-6C	
		2232U8	2232D8	2232-8W	2232-8B	2232U8M	2232D8M	2232-8C	
34"	4'	2233U4	2233D4	2233-4W	2233-4B	2233U4M	2233D4M	2233-4C	
		2233U5	2233D5	2233-5W	2233-5B	2233U5M	2233D5M	2233-5C	
		2233U6	2233D6	2233-6W	2233-6B	2233U6M	2233D6M	2233-6C	
		2233U8	2233D8	2233-8W	2233-8B	2233U8M	2233D8M	2233-8C	

8' bench legs are on 6' centers. The top overhangs legs 1' on each side.

## Open Leg Workcenters - 2300 series

As rugged as the basic open leg unit, with the added feature of a spacious lower shelf. The 2300 series provides superior strength,

with built-in versatility for adapting, adding on and custom building to match bench capability to your work needs.

Depth	Height	Length	Steel Top Backstop		Wood Tops		Hardboard Backstop		ESD Anti-Static
			With	Without	Hardwood	Bonded Wood	With	Without	
<b>30" Depth</b>									
29"	4'	2321U4	2321D4	2321-4W	2321-4B	2321U4M	2321D4M	2321-4C	
		2321U5	2321D5	2321-5W	2321-5B	2321U5M	2321D5M	2321-5C	
		2321U6	2321D6	2321-6W	2321-6B	2321U6M	2321D6M	2321-6C	
		2321U8	2321D8	2321-8W	2321-8B	2321U8M	2321D8M	2321-8C	
31 1/4"	4'	2322U4	2322D4	2322-4W	2322-4B	2322U4M	2322D4M	2322-4C	
		2322U5	2322D5	2322-5W	2322-5B	2322U5M	2322D5M	2322-5C	
		2322U6	2322D6	2322-6W	2322-6B	2322U6M	2322D6M	2322-6C	
		2322U8	2322D8	2322-8W	2322-8B	2322U8M	2322D8M	2322-8C	
34"	4'	2323U4	2323D4	2323-4W	2323-4B	2323U4M	2323D4M	2323-4C	
		2323U5	2323D5	2323-5W	2323-5B	2323U5M	2323D5M	2323-5C	
		2323U6	2323D6	2323-6W	2323-6B	2323U6M	2323D6M	2323-6C	
		2323U8	2323D8	2323-8W	2323-8B	2323U8M	2323D8M	2323-8C	

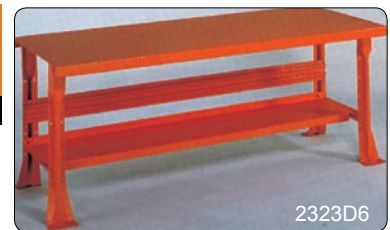

<b>36" Depth</b>									
29"	4'	2331U4	2331D4	2331-4W	2331-4B	2331U4M	2331D4M	2331-4C	
		2331U5	2331D5	2331-5W	2331-5B	2331U5M	2331D5M	2331-5C	
		2331U6	2331D6	2331-6W	2331-6B	2331U6M	2331D6M	2331-6C	
		2331U8	2331D8	2331-8W	2331-8B	2331U8M	2331D8M	2331-8C	
31 1/4"	4'	2332U4	2332D4	2332-4W	2332-4B	2332U4M	2332D4M	2332-4C	
		2332U5	2332D5	2332-5W	2332-5B	2332U5M	2332D5M	2332-5C	
		2332U6	2332D6	2332-6W	2332-6B	2332U6M	2332D6M	2332-6C	
		2332U8	2332D8	2332-8W	2332-8B	2332U8M	2332D8M	2332-8C	
34"	4'	2333U4	2333D4	2333-4W	2333-4B	2333U4M	2333D4M	2333-4C	
		2333U5	2333D5	2333-5W	2333-5B	2333U5M	2333D5M	2333-5C	
		2333U6	2333D6	2333-6W	2333-6B	2333U6M	2333D6M	2333-6C	
		2333U8	2333D8	2333-8W	2333-8B	2333U8M	2333D8M	2333-8C	

8' bench legs are on 6' centers. The top overhangs legs 1' on each side.

Pages 97-98 feature Productivity Enhancements for these benches.

Standard color - office gray. Color coordinating? Refer to the Equipto color chart - inside rear cover. Wood Tops add 1 3/4" to the overall height of the bench.

**Open Leg Workcenters - 2400 series**

Carefully engineered for rugged use with 3 sides of the top enclosed, and a bottom shelf. Equipto Series 2400 Open Leg Workcenters are extremely versatile units. Completely modular, completely flexible - with variations to match any work area requirements. A full range of easily-added accessories further expands your options.

Depth	Height	Length	Wood Tops				
			Steel with Backstop	Hardwood	Bonded Wood	Hardboard with Backstop	ESD Anti-Static
<b>30" Depth</b>							
29"	4'		2421U4	2421-4W	2421-4B	2421U4M	2421-4C
	5'		2421U5	2421-5W	2421-5B	2421U5M	2421-5C
	6'		2421U6	2421-6W	2421-6B	2421U6M	2421-6C
	8'		2421U8	2421-8W	2421-8B	2421U8M	2421-8C
31 <sup>1/4</sup> "	4'		2422U4	2422-4W	2422-4B	2422U4M	2422-4C
	5'		2422U5	2422-5W	2422-5B	2422U5M	2422-5C
	6'		2422U6	2422-6W	2422-6B	2422U6M	2422-6C
	8'		2422U8	2422-8W	2422-8B	2422U8M	2422-8C
34"	4'		2423U4	2423-4W	2423-4B	2423U4M	2423-4C
	5'		2423U5	2423-5W	2423-5B	2423U5M	2423-5C
	6'		2423U6	2423-6W	2423-6B	2423U6M	2423-6C
	8'		2423U8	2423-8W	2423-8B	2423U8M	2423-8C
<b>36" Depth</b>							
29"	4'		2431U4	2431-4W	2431-4B	2431U4M	2431-4C
	5'		2431U5	2431-5W	2431-5B	2431U5M	2431-5C
	6'		2431U6	2431-6W	2431-6B	2431U6M	2431-6C
	8'		2431U8	2431-8W	2431-8B	2431U8M	2431-8C
31 <sup>1/4</sup> "	4'		2432U4	2432-4W	2432-4B	2432U4M	2432-4C
	5'		2432U5	2432-5W	2432-5B	2432U5M	2432-5C
	6'		2432U6	2432-6W	2432-6B	2432U6M	2432-6C
	8'		2432U8	2432-8W	2432-8B	2432U8M	2432-8C
34"	4'		2433U4	2433-4W	2433-4B	2433U4M	2433-4C
	5'		2433U5	2433-5W	2433-5B	2433U5M	2433-5C
	6'		2433U6	2433-6W	2433-6B	2433U6M	2433-6C
	8'		2433U8	2433-8W	2433-8B	2433U8M	2433-8C



8' bench legs are on 6' centers. The top overhangs legs 1' on each side.

An open, modular style unit with standard features that increase bench efficiency. Everything you need to accommodate your situation — with 3 sides enclosed, aerial shelf, lower shelf, and drawer space all in one rugged unit.

**Open Leg Workcenters - 2500 series**

Depth	Height	Length	Wood Tops				
			Steel with Backstop	Hardwood	Bonded Wood	Hardboard with Backstop	ESD Anti-Static
<b>30" Depth</b>							
29"	4'		2521U4	2521-4W	2521-4B	2521U4M	2521-4C
	5'		2521U5	2521-5W	2521-5B	2521U5M	2521-5C
	6'		2521U6	2521-6W	2521-6B	2521U6M	2521-6C
	8'		2521U8	2521-8W	2521-8B	2521U8M	2521-8C
31 <sup>1/4</sup> "	4'		2522U4	2522-4W	2522-4B	2522U4M	2522-4C
	5'		2522U5	2522-5W	2522-5B	2522U5M	2522-5C
	6'		2522U6	2522-6W	2522-6B	2522U6M	2522-6C
	8'		2522U8	2522-8W	2522-8B	2522U8M	2522-8C
34"	4'		2523U4	2523-4W	2523-4B	2523U4M	2523-4C
	5'		2523U5	2523-5W	2523-5B	2523U5M	2523-5C
	6'		2523U6	2523-6W	2523-6B	2523U6M	2523-6C
	8'		2523U8	2523-8W	2523-8B	2523U8M	2523-8C
<b>36" Depth</b>							
29"	4'		2531U4	2531-4W	2531-4B	2531U4M	2531-4C
	5'		2531U5	2531-5W	2531-5B	2531U5M	2531-5C
	6'		2531U6	2531-6W	2531-6B	2531U6M	2531-6C
	8'		2531U8	2531-8W	2531-8B	2531U8M	2531-8C
31 <sup>1/4</sup> "	4'		2532U4	2532-4W	2532-4B	2532U4M	2532-4C
	5'		2532U5	2532-5W	2532-5B	2532U5M	2532-5C
	6'		2532U6	2532-6W	2532-6B	2532U6M	2532-6C
	8'		2532U8	2532-8W	2532-8B	2532U8M	2532-8C
34"	4'		2533U4	2533-4W	2533-4B	2533U4M	2533-4C
	5'		2533U5	2533-5W	2533-5B	2533U5M	2533-5C
	6'		2533U6	2533-6W	2533-6B	2533U6M	2533-6C
	8'		2533U8	2533-8W	2533-8B	2533U8M	2533-8C



8' bench legs are on 6' centers. The top overhangs legs 1' on each side.

Pages 97-98 feature Productivity Enhancements for these benches.

Standard color - office gray. Color coordinating? Refer to the Equipto color chart - inside rear cover. Wood Tops add 1<sup>3/4</sup>" to the overall height of the bench.

Workcenters

# Workcenter Accessories

## Production Boosters

- Can be used on any work bench
- Hands off use for manuals and instruments
- Shelves adjust to any angle, tip toward front or back
- Safely holds expensive test equipment
- Can triple work surface

A. 14" High Unit	For 4' Bench	For 5' Bench	For 6' Bench
With 1 Shelf	454T48	454T60	454T72
B. 24" High Unit	For 4' Bench	For 5' Bench	For 6' Bench
With 1 Shelf	451T48	451T60	451T72
With 2 Shelves	452T48	452T60	452T72
With 3 Shelves	453T48	453T60	453T72
D. 36" High Unit	For 4' Bench	For 5' Bench	For 6' Bench
With 1 Shelf	461T48	461T60	461T72
With 2 Shelves	462T48	462T60	462T72
With 3 Shelves	463T48	463T60	463T72
Extra Top Shelves	450T48	450T60	450T72

For additional intermediate shelves please contact Equipto Inside Sales

C. Cabinet	
13" D x 30" W x 27" H	Part No. 1734DI
2 required for 5' bench	
13" D x 36" W x 27" H	Part No. 1735DI
2 required for 6' bench	
None available for 4' benches	

NOTE: To order production booster with top shelf that can be tilted, substitute "—" for "T" in part number.  
 Intermediate shelves are 13<sup>1/2</sup>" D x 44", 56" or 68" L  
 Full length top shelves are 13<sup>1/2</sup>" D x 48", 60" or 72" L

## Drawers

Pilfer-proof, enclosed frame, in 2 widths and heights, for mounting up to 3 drawers wide and 3 drawers high with hasp and knockout for locks.



Drawer Size	For Bench Top Type	Starting Unit	Additional Unit	2-Drawer Stack	3-Drawer Stack
Regular Size	Steel or Hardboard on steel	221	221A	221-2	221-3
Regular Size	Wood, laminate, or ESD (Anti-Static)	221A	221A	221A2	221A3
Extra Large	Steel or hardboard on steel	223	223A	223-2	223-3*
Extra Large	Wood, laminate, or ESD (Anti-Static)	223A	223A	223A2	223A3*

\*Note: Fits only benches without bottom shelves



## Aerial Shelf

- Added space
- Gain a shelf without losing table top space

All are 12" D x 14" H

Part No. 226-30 - 30" W

Part No. 226-48 - 48" W

Part No. 226-60 - 60" W

Part No. 226-72 - 72" W

Note: Will not fit 36" D steel tops



Standard color - office gray. Color coordinating? Refer to the Equipto color chart - inside rear cover. Wood Tops add 1<sup>3/4</sup>" to the overall height of the bench.

Workcenters

**Accessories - continued**

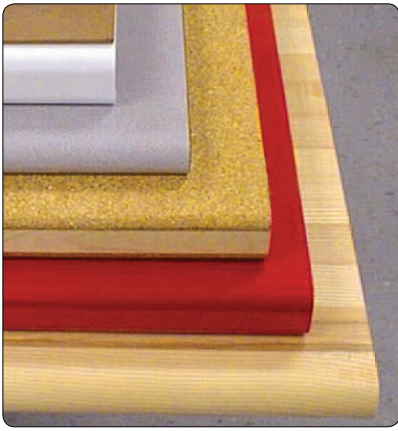

**Tops**

Style	Length	30" Deep	Stainless Steel	36" Deep Steel
Steel Top (12 gauge)	4'	441U4	441U4SS	442U4
	5'	441U5	441U5SS	442U5
With Backstop	6'	441U6	441U6SS	442U6
	8'	441U8	441U8SS	442U8
Steel Top (12 gauge)	4'	441D4	441D4SS	442D4
	5'	441D5	441D5SS	442D5
Without Backstop	6'	441D6	441D6SS	442D6
	8'	441D8	441D8SS	442D8
Stainless Steel Top	4'	441-4SSW4	—	—
With Wood Core	5'	441-5SSW4	—	—
15/8" thick	6'	441-6SSW4	—	—
	8'	441-8SSW4	—	—
Hardboard	4'	441U4M	—	442U4M
On Steel,	5'	441U5M	—	442U5M
With Backstop	6'	441U6M	—	442U6M
	8'	441U8M	—	442U8M
Hardboard	4'	441D4M	—	442D4M
On Steel,	5'	441D5M	—	442D5M
Without Backstop	6'	441D6M	—	442D6M
	8'	441D8M	—	442D8M
Bonded	4'	441-4B	—	442-4B
Wood,	5'	441-5B	—	442-5B
13/4" thick	6'	441-6B	—	442-6B
	8'	441-8B	—	442-8B
Hardwood	4'	441-4W	—	442-4W
13/4" thick	5'	441-5W	—	442-5W
	6'	441-6W	—	442-6W
	8'	441-8W	—	442-8W
ESD (Anti-Static)	4'	441-4C	—	442-4C
1 1/4" thick	5'	441-5C	—	442-5C
	6'	441-6C	—	442-6C
	8'	441-8C	—	442-8C
Plastic Laminate*	4'	441-4P	—	442-4P
1 1/4" thick	5'	441-5P	—	442-5P
	6'	441-6P	—	442-6P
	8'	441-8P	—	442-8P

\* plastic laminate unable to span greater than 60" W without center support



**Convenience cube**

12" x 12" x 12" cube. Protect fragile items or personalize a workcenter. Lock door with padlock or key lock.

Part No. 121212



**Locks**

Lock assembly fits all bench drawers and doors (padlock hasp is standard).

Description	Part No.
Key lock	10405
Keyed Alike	10405ka

**Number Plates**

Available for any number from 1 - 500 (please specify).

Number plate 13013



**Electrical Power Center**

Compact, with 4 outlets, On-Off switch, 15 Amp breaker, 15 ft. cord with ground. Easy to install where you need it.

Part No. 229-4

**Back Rail — Wood Top**

Description	Part No.
4' long	7404
5' long	7405
6' long	7406
8' long	7411
30" long	7407

**End Rail — Wood Top**

Description	Part No.
30" left	7420L
30" right	7420R
36" left	7421L
36" right	7421R

**End Rail — Steel Top**

Description	Part No.
30" left	7417L
30" right	7417R
36" left	7418L
36" right	7418R

**Closed Leg and Pedestal Workcenter - Accessories Only**

**Pedestal for Benches**

Description	Part No.
Door pedestal (no top)	233LT
4-drawer pedestal (no top)	237LT

**Legs for Benches**

Description	Part No.
Left hand closed leg panel	230L
Right hand closed leg panel	230R

**Bench Shelves**

Bench Series No.	Bench Length	Shelf Depth	Part No.
210 & 215 Series	4'	11 1/2"	6322
	5'	11 1/2"	6323
	6'	11 1/2"	6312
	8'	11 1/2"	6312
240 & 245 Series	4'	11 1/2"	6330
	5'	11 1/2"	6334
	6'	11 1/2"	6313
	8'	11 1/2"	6313
250 Series	4'	11 1/2"	6332
255 Series	5'	11 1/2"	6336
260 Series	6'	11 1/2"	6314
	8'	11 1/2"	6314

Bench Series No.	Bench Length	Shelf Depth	Part No.
265 & 270 Series	4'	19 3/4"	6327A
275 & 280 Series	5'	19 3/4"	6328A
(Intermediate Shelves)	6'	19 3/4"	6329A
	8'	19 3/4"	6329A
265 & 270 Series	4'	20 1/4"	6315
275 & 280 Series	5'	20 1/4"	6316
(Bottom Shelves)	6'	20 1/4"	6317
	8'	20 1/4"	6317

Standard color - office gray. Color coordinating? Refer to the Equipto color chart - inside rear cover. Wood Tops add 1 3/4" to the overall height of the bench.

Workcenters

**Iron-I Workcenter - Accessories**



Equipto Iron-I Benches have the flexibility for planned expansion. Our parts and accessories allow you to keep up with changing requirements.

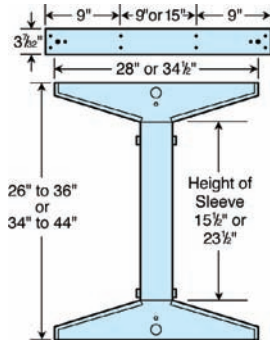

**IRON-I**

**Bench Legs**

Depth	Height	Part No.
29"	26" - 36"	420L30
35"	26" - 36"	420L36
29"	34" - 44"	420H30
35"	34" - 44"	420H36

The Iron-I's legs adjust from heights of 26" to 44" in 1/2" increments. All structural parts are 12 gauge (.104") steel. **Each leg will support 1,000 lbs.**

**Bench Base**

Length	Part No.
4'	6844
5'	6845
6'	6846

**Swivel Caster Set**

Quantity	Part No.
4	11649-04

**Leveler Set**

Quantity	Part No.
4	11650-04

**Bottom Shelves**

Description	Part No.
13 1/2" x 48"	6054
13 1/2" x 60"	6055
13 1/2" x 72"	6056

**Open Leg Workcenters - Accessories**

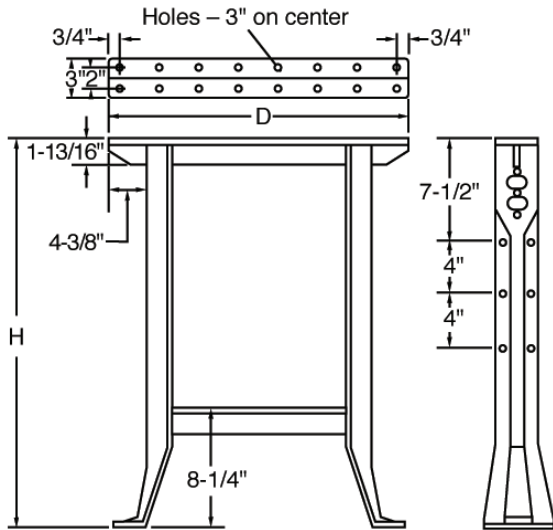

**Bench Legs**

Welded, one-piece steel units seamed for strength and safety.

Depth	Height	Part No.
<b>Nominal 30"</b>		
28 1/2"	29"	9921
28 1/2"	31 1/4"	9922
28 1/2"	34"	9923
<b>Nominal 36"</b>		
34 1/2"	29"	9931
34 1/2"	31 1/4"	9932
34 1/2"	34"	9933

**Back Stringers**

Size	Part No.
4'	10251
5'	10252
6'	10253

**Bottom Shelves**

Description	Part No.
127/8" x 4'	6120
127/8" x 5'	6121
127/8" x 6'	6122

**Mobile Caster Kit for Bench**

Mobile Kit adds 7 1/2" to the height of bench

Depth	Part No.
30"	2203
36"	2204

Caster kits include: (4) locking swivel casters  
1200 total lb. capacity per set of 4



Standard color - office gray. Color coordinating? Refer to the Equipto color chart - inside rear cover. Wood Tops add 1 3/4" to the overall height of the bench.

# Tech Bench Workcenters

The Equipto Tech Bench combines essential service facility equipment and Hi-tech storage functionality to organize every aspect of a technician's workspace

# EQUIPTO TECH BENCH



Concealed reel holder compartments, sliding lift control drawers and retractable cabinet doors provide a professional, streamlined appearance.

Workcenters



### Lift Control Drawer

Provides hidden compartment to mount the lift control power unit and easily slides out to provide quick and convenient access for servicing.

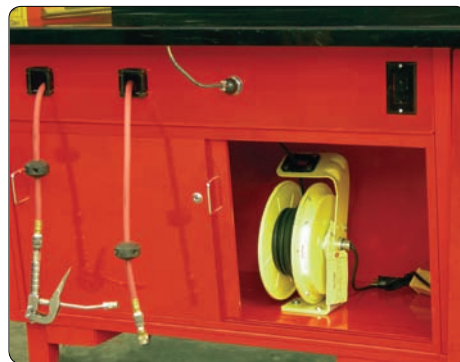

### Lower Bench Cabinets

Neatly organize and conceal reel holders for air, water and lubricants behind removable sliding cabinet doors. Prevent dirt, trash and debris from collecting and obstructing reel unwinding and rewinding.



### Monitor Enclosure

Offers eye-level storage compartment for service computer monitor. Retractable keyboard tray adjusts to individual user level and is center mounted under the monitor enclosure.

Standard color - office gray. Color coordinating? Refer to the Equipto color chart - inside rear cover.

**1st**

**Tech Bench Workcenters - Preconfigured Units**

**Select the lower bench unit**

Select the sliding door or removable panel lower bench configuration;  
Available in 4', 5', 6', 8' and 10' lengths.

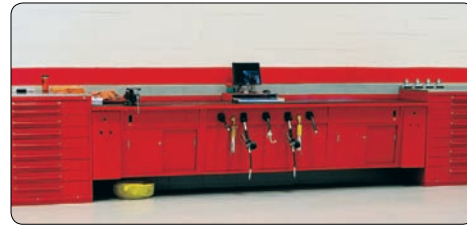

**Stainless Steel Top - Preconfigured Units**

16 gauge solid steel over wood core, wall-mount workcenter with a one piece top and integral backstop.  
Cabinets feature sliding/removable doors for storage or servicing of equipment.  
Includes knockouts for electrical outlets and hoses. (Electrical outlets and hoses not included).  
Standard cover plates are included, specialty cover plates are listed in the Options section on page 103.

**Sliding door lower bench units**

Part No.	Description
TBL10S-55DN	Includes two 60" sliding door bench units with a 10' stainless steel top - 120"W x 30"D x 28 <sup>3</sup> / <sub>4</sub> "H
TBL10S-44DE	Includes two 48" sliding door bench units with one 12" overhang on each end with a stainless steel top - 120"W x 30"D x 28 <sup>3</sup> / <sub>4</sub> "H
TBL10S-44DC	Includes two 48" sliding door bench units with one 24" center opening with a stainless steel top - 120"W x 30"D x 28 <sup>3</sup> / <sub>4</sub> "H
TBL8S-44DN	Includes two 48" sliding door bench units with a 8' stainless steel top - 96"W x 30"D x 28 <sup>3</sup> / <sub>4</sub> "H
TBL8S-33DE	Includes two 36" sliding door bench units with one 12" overhang on each end with a stainless steel top - 96"W x 30"D x 28 <sup>3</sup> / <sub>4</sub> "H
TBL6S-5DE	Includes one 60" sliding door bench unit with one 12" overhang with a stainless steel top - 72"W x 30"D x 28 <sup>3</sup> / <sub>4</sub> "H
TBL5S-5DN	Includes one 60" sliding door bench unit with a 5' stainless steel top - 60"W x 30"D x 28 <sup>3</sup> / <sub>4</sub> "H
TBL4S-3DE	Includes one 36" sliding door bench unit with one 12" overhang with a stainless steel top - 48"W x 30"D x 28 <sup>3</sup> / <sub>4</sub> "H

**Removable door lower bench units**

Part No.	Description
TBL10S-55PN	Includes two 60" removable panel bench units with a 10' stainless steel top - 120"W x 30"D x 28 <sup>3</sup> / <sub>4</sub> "H
TBL10S-44PE	Includes two 48" removable panel bench units with one 12" overhang on each end with a stainless steel top - 120"W x 30"D x 28 <sup>3</sup> / <sub>4</sub> "H
TBL10S-44PC	Includes two 48" removable panel bench units with one 24" center opening with a stainless steel top - 120"W x 30"D x 28 <sup>3</sup> / <sub>4</sub> "H
TBL8S-44PN	Includes two 48" removable panel bench units with a 8' stainless steel top - 96"W x 30"D x 28 <sup>3</sup> / <sub>4</sub> "H
TBL8S-33PE	Includes two 36" removable panel bench units with one 12" overhang on each end with a stainless steel top - 96"W x 30"D x 28 <sup>3</sup> / <sub>4</sub> "H
TBL6S-5PE	Includes one 60" removable panel bench unit with one 12" overhang with a stainless steel top - 72"W x 30"D x 28 <sup>3</sup> / <sub>4</sub> "H
TBL5S-5PN	Includes one 60" removable panel bench unit with a 5' stainless steel top - 60"W x 30"D x 28 <sup>3</sup> / <sub>4</sub> "H
TBL4S-3PE	Includes one 36" removable panel bench unit with one 12" overhang with a stainless steel top - 48"W x 30"D x 28 <sup>3</sup> / <sub>4</sub> "H

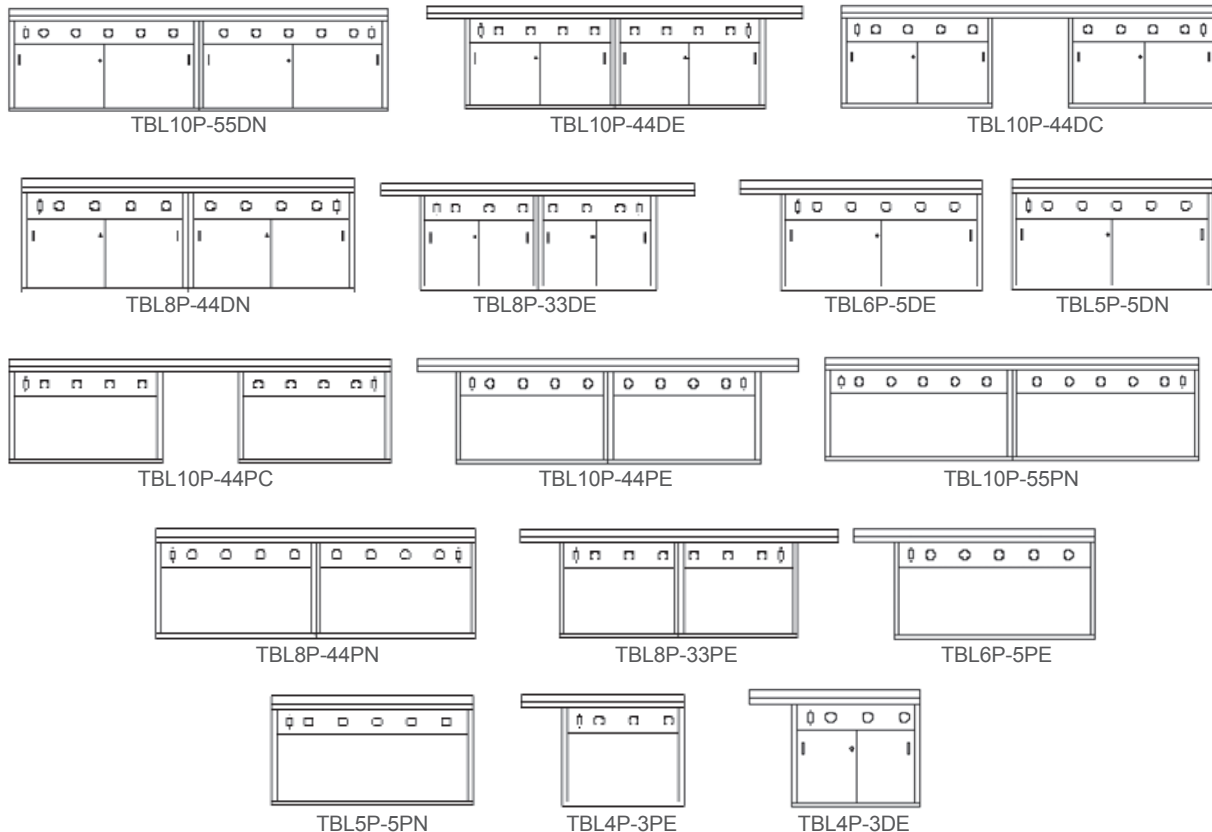

Standard color - office gray. Color coordinating? Refer to the Equipto color chart - inside rear cover.

Workcenters



**Optional Painted Steel Top - Preconfigured units**

Painted 16 gauge solid steel over a wood core, wall-mount work center with a one piece top and integral backstop. Cabinets feature sliding/removable doors for storage or servicing of equipment. Includes knockouts for electrical outlets and hoses. (Electrical outlets and hoses not included). Standard cover plates are included, specialty cover plates are listed in the Options section on page 103.

**Sliding door lower bench units**

Part No.	Description
TBL10P-55DN	Includes two 60" sliding door bench units with a 10' painted steel top - 120"W x 30"D x 28 <sup>3/4</sup> "H
TBL10P-44DE	Includes two 48" sliding door bench units with one 12" overhang on each end with a painted steel top - 120"W x 30"D x 28 <sup>3/4</sup> "H
TBL10P-44DC	Includes two 48" sliding door bench units with one 24" center opening with a painted steel top - 120"W x 30"D x 28 <sup>3/4</sup> "H
TBL8P-44DN	Includes two 48" sliding door bench units with a 8' painted steel top - 96"W x 30"D x 28 <sup>3/4</sup> "H
TBL8P-33DE	Includes two 36" sliding door bench units with one 12" overhang on each end with a painted steel top - 96"W x 30"D x 28 <sup>3/4</sup> "H
TBL6P-5DE	Includes one 60" sliding door bench unit with one 12" overhang with a painted steel top - 72"W x 30"D x 28 <sup>3/4</sup> "H
TBL5P-5DN	Includes one 60" sliding door bench unit with a 5' painted steel top - 60"W x 30"D x 28 <sup>3/4</sup> "H
TBL4P-3DE	Includes one 36" sliding door bench unit with one 12" overhang with a painted steel top - 48"W x 30"D x 28 <sup>3/4</sup> "H

**Removable door lower bench units**

Part No.	Description
TBL10P-55PN	Includes two 60" removable panel bench units with a 10' painted steel top - 120"W x 30"D x 28 <sup>3/4</sup> "H
TBL10P-44PE	Includes two 48" removable panel bench units with one 12" overhang on each end with a painted steel top - 120"W x 30"D x 28 <sup>3/4</sup> "H
TBL10P-44PC	Includes two 48" removable panel bench units with one 24" center opening with a painted steel top - 120"W x 30"D x 28 <sup>3/4</sup> "H
TBL8P-44PN	Includes two 48" removable panel bench units with a 8' painted steel top - 96"W x 30"D x 28 <sup>3/4</sup> "H
TBL8P-33PE	Includes two 36" removable panel bench units with one 12" overhang on each end with a painted steel top - 96"W x 30"D x 28 <sup>3/4</sup> "H
TBL6P-5PE	Includes one 60" removable panel bench unit with one 12" overhang with a painted steel top - 72"W x 30"D x 28 <sup>3/4</sup> "H
TBL5P-5PN	Includes one 60" removable panel bench unit with a 5' painted steel top - 60"W x 30"D x 28 <sup>3/4</sup> "H
TBL4P-3PE	Includes one 36" removable panel bench unit with one 12" overhang with a painted steel top - 48"W x 30"D x 28 <sup>3/4</sup> "H

examples shown on previous page

**Tech Bench Workcenters - Preconfigured Units**

**2<sup>nd</sup>**

**Select the upper cabinet unit**

Available in 4', 5', 6', 8' and 10' lengths.

Wall-mount cabinet unit with your choice of retractable sliding cabinet and/or gas shock door, and one 24" monitor enclosure with retracting keyboard tray.

Part No.	Description
TBU10-4M4	Includes two 48" storage cabinets and one 24" monitor cabinet - 120"W x 15"D x 21"H
TBU8-3M3	Includes two 36" storage cabinets and one 24" monitor cabinet - 96"W x 15"D x 21"H
TBU6-M4	Includes one 48" storage cabinet and one 24" monitor cabinet - 72"W x 15"D x 21"H
TBU5-M3	Includes one 36" storage cabinet and one 24" monitor cabinet - 60"W x 15"D x 21"H
TBU4-M2	Includes one 24" storage cabinet and one 24" monitor cabinet - 48"W x 15"D x 21"H
TBU-PSMK	Bracket to mount to 16 <sup>1/2</sup> " deep Aerial Shelf – plastic top
TBU-SSMK	Bracket to mount to 16 <sup>1/2</sup> " deep Aerial Shelf – steel top

For **GAS SHOCK** attachment, simply add "GS" to the end of the cabinet part number.

If you would like to have multiple door options, please contact Equipto Inside Sales for a customized quote.

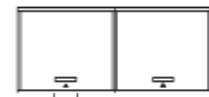

TBU4-M2



TBU5-M3

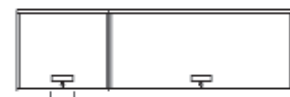

TBU6-M4



TBU8-3M3

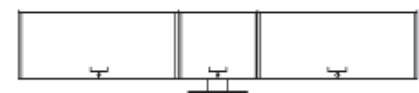

TBU10-4M4

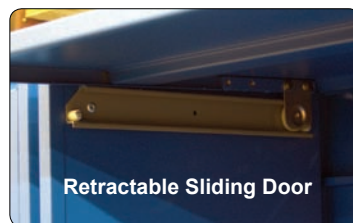

Standard color - office gray. Color coordinating? Refer to the Equipto color chart - inside rear cover.

**Back Braces - for wall mount units only**

Uni-strut or equivalent structural channels and appropriate hardware are required to hang upper and lower cabinets from wall and are not provided.

**Back braces are required on lower cabinets for wall hanging only.**

Part No.	Description
TBWMK-2	size of brace - 24"
TBWMK-3	size of brace - 36"
TBWMK-4	size of brace - 48"
TBWMK-5	size of brace - 60"

**Free-standing kits**

Part No.	Description
TBFSK-2	Free Standing Kit - 24"
TBFSK-3	Free Standing Kit - 36"
TBFSK-4	Free Standing Kit - 48"
TBFSK-5	Free Standing Kit - 60"

**For lower units only**

Description	
TBFSK-2L	Free Standing Kit - 24"
TBFSK-3L	Free Standing Kit - 36"
TBFSK-4L	Free Standing Kit - 48"
TBFSK-5L	Free Standing Kit - 60"



**Tech Bench Workcenters - Accessories**

Select desired accessories. For additional lift control drawer options, contact Equipto.

**Optional Accessories**

Part No.	Description
Contact Equipto Inside Sales reps for proper lift control parts	
TBCW-2 (S*)	Painted Steel Chaseway - 24"W
TBCW-3 (S*)	Painted Steel Chaseway - 36"W
TBCW-4 (S*)	Painted Steel Chaseway - 48"W
TBCW-5 (S*)	Painted Steel Chaseway - 60"W
TBCW-6 (S*)	Painted Steel Chaseway - 72"W
TBCW-8 (S*)	Painted Steel Chaseway - 96"W
TBCW-10 (S*)	Painted Steel Chaseway - 120"W
TBRM-3	Rubber Mat - 36"W

\*Add "S" to end of PN for Stainless Steel Chaseway

Part No.	Description
TBRM-4	Rubber Mat - 48"
TBRM-5	Rubber Mat - 60"
TBRM-6	Rubber Mat - 72"
TBRM-8	Rubber Mat - 96"
TBRM-10	Rubber Mat - 120"
TBRK	4 pc. Roller Kit
TBCP-NE	Cover Plate (No Electric)
TBCP-WE	Cover Plate (With Electric)
TBCP-LR	Cover Plate For Light Reel
TBCP-RK	Standard Cover Plate
TBLHS-3	Lower Half Shelf - 36"
TBLHS-4	Lower Half Shelf - 48"
TBLHS-5	Lower Half Shelf - 60"

**Tech Bench Workcenters - Modular Components**

**Upper cabinet components**

Part No.	Description
TBU-2	Upper Cabinet - 24"
TBU-M	Upper Monitor Cabinet - 24"
TBU-3	Upper Cabinet - 36"
TBU-4	Upper Cabinet - 48"
TBU-2GS	Upper Cabinet w/ gas shocks - 24"
TBU-MGS	Upper Monitor Cabinet w/ gas shocks - 24"
TBU-3GS	Upper Cabinet w/ gas shocks - 36"
TBU-4GS	Upper Cabinet w/ gas shocks - 48"

**Note: Upper Cabinet Units have an 18" high clearance when the cabinet doors are retracted.**

**Lower cabinet components**

Part No.	Description
TBL-2P	With Removable Panel - 24"
TBL-3P	With Removable Panel - 36"
TBL-4P	With Removable Panel - 48"
TBL-5P	With Removable Panel - 60"
TBL-3D	With Sliding Doors - 36"
TBL-4D	With Sliding Doors - 48"
TBL-5D	With Sliding Doors - 60"
TBLCD-SC	Side Cover for Lift Control Drawer

Note: Lower bench top not included.

**Lower bench tops steel/wood core**

Part No.	Description
TBT-3P	Painted Steel Top - 36"
TBT-4P	Painted Steel Top - 48"
TBT-5P	Painted Steel Top - 60"
TBT-6P	Painted Steel Top - 72"
TBT-8P	Painted Steel Top - 96"
TBT-10P	Painted Steel Top - 120"
TBT-3S	Stainless Steel Top - 36"
TBT-4S	Stainless Steel Top - 48"
TBT-5S	Stainless Steel Top - 60"
TBT-6S	Stainless Steel Top - 72"
TBT-8S	Stainless Steel Top - 96"
TBT-10S	Stainless Steel Top - 120"

**Note: Lower Bench Tops have a rear overhang of 1 1/4" and a front overhang of 4 1/2".**

**Upper cabinets**



**Lower Cabinets**

Panel Front

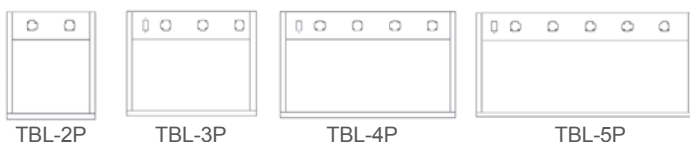

Sliding Door Front

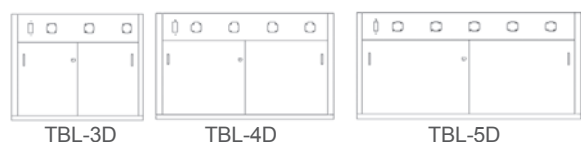

Standard color - office gray. Color coordinating? Refer to the Equipto color chart - inside rear cover.

# Equiptoflex Workcenters

This is the most flexible technical workcenter available. Designed ergonomically for the 21st century, it changes with you. Three sizes of cabinets, four sizes of drawers, four sizes of doors and six choices of work surfaces mean almost limitless design options for you. Add to

that, electrical legs, bottom shelves, locks, aerial shelves with or without electrical outlets, and Equipto cabinets, and seating, and you have a total, flexible, technical workcenter. One that adapts to your changing requirements!

- These attractive workcenters compliment and enhance other Equipto workcenters and modular drawers.
- 100% extension on drawers
- Hinged Doors
- Shelves
- Quiet Ride™ drawers
- UL approved fused electrical outlets
- ESD paint available
- 6 work surfaces from which to choose
- 100 lb. capacity per drawer
- Pre-engineered units
- Custom designed units
- Built-in label holder
- Optional unit locking mechanism
- Leveling feet



389 Series

**Use In:**

- Assembly
- Maintenance
- Manufacturing
- Office
- Hospitals
- Mail Room
- Packaging
- Technical
- Electronics

## Equipto Workcenters - Preconfigured Units



360R (with 311 monitor riser)

The left cabinet, in the main work surface area, consists of two 3”H drawers, one 6”H drawer and one 12”H file drawer.

In the right return area, the cabinet consists of two 12” high file drawers.

Main work area is 72”W x 36”D and return is 48”W x 30”D. Work surface is 30”H. Model 360R.

To order unit with a left hand return instead of a right hand return order model 360L.

**Desktop Choices:**

Desk type	Plastic Laminate**		Hardwood**	
	6' end	4' end	6' end	4' end
Left hand	12327L	12367L	12327WL	12367WL
Right hand	12327R	12367R	12327WR	12367WR

\*\* Order both 6' and 4' part numbers for a complete top.

\*\*Wood Tops add 1 3/4" to the overall height of the bench.

Standard color - Office gray. For other colors refer to the Equipto color chart on the rear cover.

Workcenters

**Equiptoflex Workcenters - 29" Desk Height**

**363 series**

Work Surface Type	Workcenter Widths		
	4'	5'	6'
Plastic Laminate	363R4P	363R5P	363R6P
ESD (Anti-Static)	363R4C	363R5C	363R6C
Hardwood	363R4W	363R5W	363R6W
Bonded Wood	363R4B	363R5B	363R6B

Left hand cabinet with two 3"H drawers; four 4<sup>1/2</sup>"H drawers. Right hand cabinet with one full height 24"H door and one interior adjustable shelf. To order unit with cabinets reversed left to right, change letter in catalog number from "R" to "L". Bottom shelf on all workcenters. Drawer cabinet has central lock; door has individual lock.



Model 363R5P

**364 series**

Work Surface Type	Workcenter Widths		
	4'	5'	6'
Plastic Laminate	364R4P	364R5P	364R6P
ESD (Anti-Static)	364R4C	364R5C	364R6C
Hardwood	364R4W	364R5W	364R6W
Bonded Wood	364R4B	364R5B	364R6B

Left hand cabinet with one 3"H drawer; two 4<sup>1/2</sup>"H drawers; one 12" H hanging file drawer. Right hand cabinet with two 12"H doors and one adjustable shelf between doors. To order unit with cabinets reversed left to right, change letter in catalog number from "R" to "L". Bottom shelf on all work-centers. Drawer cabinet has central lock; doors have individual locks.



Model 364R5P

**365 series**

Work Surface Type	Workcenter Widths		
	4'	5'	6'
Plastic Laminate	365-4P	365-5P	365-6P
ESD (Anti-Static)	365-4C	365-5C	365-6C
Hardwood	365-4W	365-5W	365-6W
Bonded Wood	365-4B	365-5B	365-6B
12 Gauge Steel	365-4T	365-5T	365-6T
Hardboard on Steel	365-4M	365-5M	365-6M

Left hand cabinet with two 3"H drawers; one 6"H drawer; one 12"H hanging file drawer. Right hand cabinet with two 6"H drawers; and one 12"H hanging file drawer. Bottom shelf on all workcenters. All units complete with cabinet locks.



Model 365-5P

**366 series**

Work Surface Type	Workcenter Widths		
	4'	5'	6'
Plastic Laminate	366L4P	366L5P	366L6P
ESD (Anti-Static)	366L4C	366L5C	366L6C
Hardwood	366L4W	366L5W	366L6W
Bonded Wood	366L4B	366L5B	366L6B
12 Gauge Steel	366L4T	366L5T	366L6T
Hardboard on Steel	366L4M	366L5M	366L6M

One cabinet with one 3"H drawer; two 4<sup>1/2</sup>"H drawers; one 12"H hanging file drawer. One pedestal leg with UL approved fused electrical outlets. Bottom shelf on all workcenters. All units complete with cabinet lock. To order unit with cabinet reversed from left to right, change letter in catalog number from "L" to "R".



Model 366L5P

**367 series**

Work Surface Type	Workcenter Widths		
	4'	5'	6'
Plastic Laminate	367-4P	367-5P	367-6P
ESD (Anti-Static)	367-4C	367-5C	367-6C
Hardwood	367-4W	367-5W	367-6W
Bonded Wood	367-4B	367-5B	367-6B
12 Gauge Steel	367-4T	367-5T	367-6T
Hardboard on Steel	367-4M	367-5M	367-6M

Two pedestal legs with UL approved fused electrical outlets. Bottom shelf and modesty panel on all workcenters.



Model 367-5P

Page 107 features Productivity Enhancements for these benches.

Standard color - Office gray. For other colors refer to the Equipto color chart on the rear cover.

**Equiptoflex Workcenters - Desk Height 33<sup>1</sup>/<sub>2</sub>"**



**384 Series**

Work Surface Type	Workcenter Width		
	4'	5'	6'
Plastic Laminate	384R4P	384R5P	384R6P
ESD (Anti-Static)	384R4C	384R5C	384R6C
Hardwood	384R4W	384R5W	384R6W
Bonded Wood	384R4B	384R5B	384R6B

Left hand cabinet with one drawer 4<sup>1</sup>/<sub>2</sub>"H; four drawers 6"H. Right hand cabinet with one full height door, 28<sup>1</sup>/<sub>2</sub>"H. To order unit with cabinets reversed right to left, change letter in catalog number from "R" to "L". Bottom shelf on all workcenters. Drawer cabinet has central lock; door has individual lock.

**385 Series**

Work Surface Type	Workcenter Width		
	4'	5'	6'
Plastic Laminate	385-4P	385-5P	385-6P
ESD (Anti-Static)	385-4C	385-5C	385-6C
Laminated Maple	385-4W	385-5W	385-6W
Hardwood	385-4B	385-5B	385-6B
12 Gauge Steel	385-4T	385-5T	385-6T
Hardboard on Steel	385-4M	385-5M	385-6M

One cabinet with one drawer 4<sup>1</sup>/<sub>2</sub>"H; four drawers 6"H. One cabinet with two drawers 3"H; one drawer 4<sup>1</sup>/<sub>2</sub>"H; one drawer 6"H; one 12"H hanging file drawer. Bottom shelf on all workcenters. All units complete with cabinet locks.

**386 Series**

Work Surface Type	Workcenter Width		
	4'	5'	6'
Plastic Laminate	386R4P	386R5P	386R6P
ESD (Anti-Static)	386R4C	386R5C	386R6C
Hardwood	386R4W	386R5W	386R6W
Bonded Wood	386R4B	386R5B	386R6B
12 Gauge Steel	386R4T	386R5T	386R6T
Hardboard on Steel	386R4M	386R5M	386R6M

Left hand cabinet with one drawer 3"H; three drawers 4<sup>1</sup>/<sub>2</sub>"H; two drawers 6"H. Right hand cabinet with one drawer 4<sup>1</sup>/<sub>2</sub>"H; one door 24"H with one interior adjustable shelf. All units complete with door and cabinet locks. To order unit with cabinet reversed from right to left, change letter in catalog number from "R" to "L".

**387 Series**

Work Surface Type	Workcenter Width		
	4'	5'	6'
Plastic Laminate	387R4P	387R5P	387R6P
ESD (Anti-Static)	387R4C	387R5C	387R6C
Hardwood	387R4W	387R5W	387R6W
Bonded Wood	387R4B	387R5B	387R6B
12 Gauge Steel	387R4T	387R5T	387R6T
Hardboard on Steel	387R4M	387R5M	387R6M

One cabinet with one 3"H drawer; three 4<sup>1</sup>/<sub>2</sub>"H drawers; one 12"H hanging file drawer. Pedestal leg with UL approved fused electrical outlets. Bottom shelf on all workcenters. All units complete with cabinet lock. To order unit with cabinets reversed right to left, change letter in catalog number from "R" to "L".

**388 Series**

Work Surface Type	Workcenter Width		
	4'	5'	6'
Plastic Laminate	388-4P	388-5P	388-6P
ESD (Anti-Static)	388-4C	388-5C	388-6C
Hardwood	388-4W	388-5W	388-6W
Bonded Wood	388-4B	388-5B	388-6B
12 Gauge Steel	388-4T	388-5T	388-6T
Hardboard on Steel	388-4M	388-5M	388-6M

With two pedestal legs with UL approved fused electrical outlets. Bottom shelf and modesty panel on all workcenters.

**389 Series**

Work Surface Type	Workcenter Width		
	4'	5'	6'
Plastic Laminate	389R4P	389R5P	389R6P
ESD (Anti-Static)	389R4C	389R5C	389R6C
Hardwood	389R4W	389R5W	389R6W
Bonded Wood	389R4B	389R5B	389R6B

Left hand cabinet with one 4<sup>1</sup>/<sub>2</sub>"H drawer; two 6"H drawers; one 12"H door. Right hand cabinet with one full height 28<sup>1</sup>/<sub>2</sub>"H door with one adjustable interior shelf. To order unit with cabinets reversed right to left, change letter in catalog number from "R" to "L". Bottom shelf and 12"H plastic laminate aerial shelf with UL approved fused electrical outlet riser supports on all workcenters. (ESD (Anti-Static) top workcenter is furnished with ESD (Anti-Static) aerial shelf. To order steel aerial shelf, as shown, refer to accessories, page 107.)

Standard color - Office gray. For other colors refer to the Equipto color chart on the rear cover.

Workcenters

**Equiptoflex Workcenters - Accessories**

15" wide cabinets compliment your equipto drawers by adding convenience and flexibility. Use them individually, on wheels or as flexible technical workcenters.

**Design your own equipto workcenter**



**1st Select cabinet frames and/or pedestal legs. Frames for 15" wide cabinets**

**Right Hand Bench Cabinet**

Height	No Lock	Top Lock	Points.
33 1/2"	487NLR	487TLR	95
29"	486NLR	486TLR	80
24 1/2"	485NLR	485TLR	65

**Left Hand Bench Cabinet**

Height	No Lock	Top Lock	Points.
33 1/2"	487NLL	487TLL	95
29"	486NLL	486TLL	80
24 1/2"	485NLL	485TLL	65

**Free Standing Cabinet (Not used with workcenter)**

Height	No Lock	Top Lock	Points.
33 1/2"	487NLE	487TLE	95
29"	486NLE	486TLE	80
24 1/2"	485NLE	485TLE	65

Above units include leveling feet.

**Pedestal legs (3" w)**

Height	With		Without	
	Electric Outlets	Without Electric Outlets	Electric Outlets	Without Electric Outlets
24 1/2"	495EL	495NE	495NE	495NE
29"	496EL	496NE	496NE	496NE
33 1/2"	497EL	497NE	497NE	497NE



Includes leveling feet. Equipto workcenter with 2 pedestal legs requires Steel Modesty Panel.

**2nd Fill cabinet frames with doors or drawers**

Drawer Height	Part No.	Useable Height	Points
3"	541-10	2 9/16"	10
4 1/2"	542-15	4 1/16"	15
6"	543-20	5 9/16"	20
12"	547-40	11 9/16"	40

Door Height	Part No.	Useable Height	Points
12"	550L40*	12"	40
	550R40		
19 1/2"	553L65*	19 1/2"	65
	553R65		
24"	554L80*	24"	80
	554R80		
28 1/2"	555L95*	28 1/2"	95
	555R95		

\* L & R indicate which side of cabinet has door hinge. The last 2 digits of the drawer/door selection must total the number of points associated with each cabinet size. Ex: 4 - #543-20 have 4 x 20 = 80 points, which fills cabinet #486. Inside dimensions of drawers are 12" W x 25" D. Clear height 7/16" less than nominal height.

Note: Spacer channel #540-05 is required at top of cabinet when any steel top is used. Full cabinet height door may not be used.

**3rd Add lower recessed shelf or panel (required).**

**Recessed lower shelf**

For Use in Equiptoflex Workcenter:

Width	Two Cabinets	One Cabinet & One Leg	Two Legs
4'	470T4	471T4	472T4
5'	470T5	471T5	472T5
6'	470T6	471T6	472T6

**Full Height Modesty Panels**

Height	Width	Part No.
24" H	4'	476-4
	5'	476-5
	6'	476-6
29" H	4'	477-4
	5'	477-5
	6'	477-6
33" H	4'	478-4
	5'	478-5
	6'	478-6

**4th Select work surface**

**Tops**

Style	Length	30" Deep
Steel Top (12 gauge)*	4'	441U4
	5'	441U5
With Backstop	6'	441U6
Hardboard	4'	441U4M
On Steel,	5'	441U5M
With Backstop	6'	441U6M
Bonded Wood, 1 3/4" thick	4'	441-4B
	5'	441-5B
	6'	441-6B
Laminated Hardwood 1 3/4" thick	4'	441-4W
	5'	441-5W
	6'	441-6W
ESD (Anti-Static) 1 1/4" thick	4'	441-4C
	5'	441-5C
	6'	441-6C
Laminated Plastic, 1 1/4" thick	4'	441-4P
	5'	441-5P
	6'	441-6P

\*Note-Spacer channel #540-05 is required at top of cabinet when any steel top is used.

**Steel monitor risers**

Sturdy **Steel Monitor Risers** elevate computer monitor above work area and create space for keyboard when not in use. Risers have soft rubber feet to eliminate marking desktops and can be painted to match Equipto workstation. Available in two sizes.



Part No.	Dimensions
310	12" D x 12" W x 4 1/2" H
311	12" D x 24 1/2" W x 4 1/2" H

**5th Add optional accessories.**



**Aerial shelf assembly (2 riser supports, shelf and back panel).**

Type of Shelf	Steel		Conductive		Plastic Laminate	
	w/elec.	w/o elec.	w/elec.	w/o elec.	w/elec.	w/o elec.
<b>14" High (depth of top surface is 13 1/2")</b>						
4'	464T4	466T4	464C4	466C4	464P4	466P4
5'	464T5	466T5	464C5	466C5	464P5	466P5
6'	464T6	466T6	464C6	466C6	464P6	466P6

<b>24" High (depth of top surface is 16 1/2")</b>						
4'	467T4	469T4	467C4	469C4	467P4	469P4
5'	467T5	469T5	467C5	469C5	467P5	469P5
6'	467T6	469T6	467C6	469C6	467P6	469P6

Add "W" for wire back grid panel. (Available only in 14" height)

Note: Units with electrical include power in both left and right aerial shelf riser supports.

**Gray cloth tackboard for aerial shelf**

Back panel			
Width	4'	5'	6'
14" High	538-4	538-5	538-6

**Drawer dividers (left to right)**

Drawer Height	Part No.
3"	8891
4 1/2"	8892
6"	8893

**Accessories**

Pullout Under Counter Shelf (for computer keyboard)	537
Cabinet unit lock	3101
Door lock	3103
Adjustable shelf	539-05
1 1/2" spacer strip (for use with flange down steel tops)	540-05
3" High Mobile Wheel kit (mobilizes any Equiptoflex cabinet)	4406
Task Light (for under aerial shelf)	307
Spacer (for steel top)	9240
Paper label	224995
Mylar label cover	224994
Plastic end caps for handles (left)	993102L
Plastic end caps for handles (right)	993102R

Standard color - Office gray. For other colors refer to the Equipto color chart on the rear cover.

**Equipto Workcenters - Accessories**

**Chairs**

Rugged, attractive, and made for comfort in all-day, every-day use, these Equipto chairs feature sculptured foam and versatile customizing adjustments to fit the chair to the individual user.



1423-14



1435-14



1434-14



1429-14

Sit/Stand Chair



1425-05



1422-04



1435-04

	Seat Height	Pneumatic Lift	Back Angle Adjustment	Adjustable Foot Ring	Casters** or Glides	Urethane Post Arms	Part No.
Manager Chair	17 <sup>1</sup> / <sub>4</sub> " - 22 <sup>1</sup> / <sub>4</sub> "	X			Glides	optional	1423-14*
	22 <sup>1</sup> / <sub>4</sub> " - 29 <sup>1</sup> / <sub>4</sub> "	X			Glides	optional	1430-14*
	24 <sup>1</sup> / <sub>4</sub> " - 34 <sup>1</sup> / <sub>4</sub> "	X		X	Glides	optional	1435-14*
Upholstered	24 <sup>1</sup> / <sub>2</sub> " - 31 <sup>3</sup> / <sub>4</sub> "	X	X	X	Casters		1427-14
Production Chair	26 <sup>3</sup> / <sub>4</sub> " - 36 <sup>3</sup> / <sub>4</sub> "	X	X	X	Casters		1434-14
	26 <sup>3</sup> / <sub>4</sub> " - 36 <sup>3</sup> / <sub>4</sub> "	X		X	Casters		1429-14
	17 <sup>1</sup> / <sub>2</sub> " - 22 <sup>1</sup> / <sub>4</sub> "	X			Glides	optional	1422-04*
	22 <sup>1</sup> / <sub>4</sub> " - 29 <sup>1</sup> / <sub>4</sub> "	X			Glides	optional	1430-04*
	24 <sup>1</sup> / <sub>4</sub> " - 34 <sup>1</sup> / <sub>4</sub> "	X		X	Glides	optional	1435-04*
	23 <sup>1</sup> / <sub>2</sub> " - 28 <sup>3</sup> / <sub>4</sub> "	X		X	Casters		1429-04
	26 <sup>1</sup> / <sub>2</sub> " - 36 <sup>1</sup> / <sub>4</sub> "	X		X	Casters		1434-04
	Sit/Stand Chair	17 <sup>1</sup> / <sub>4</sub> " - 25 <sup>1</sup> / <sub>4</sub> "	X	X		Glides	

\*See option chart for additional features available on specific chairs. All chairs can have optional arms, back angles adjustment and/or casters.

\*\*All chairs except 1425-05 are available with either casters or glides.

**Chairs - Accessories**

Options		Casters	
ESD Option, Fabric/Vinyl	ESD	2" Soft Rubber Ball Bearing	2SR
Clean Room Option (No dust)	CRO	2" ESD Soft Rubber Ball Bearing	2ESR
Forward Tilt Posture Back	PBFT	2" Dual Hard Wheel/Carpet	2H
Adj. Foot Ring 20"	AFR20	2" ESD Dual Hard Wheel/Carpet	2EH
Urethane Post Arms	UPA	Add suffix to Part No. to order options	
Urethane Adjust. Post Arms	UAPA	(Example: 1423-14 UAPA)	

Standard color - Office gray. For other colors refer to the Equipto color chart on the rear cover.

Workcenters

Standard color - office gray. Color coordinating? Refer to the Equipto color chart - inside rear cover. Wood Tops add 1<sup>3/4</sup>" to the overall height of the bench.